

53 (2')

3000
(10')
standard
max.

36500
(120')
custom
max.

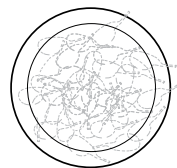

625
(24.6')

755
(29.7')

Approved to UL standards by CSA



approx 27.5kg (60lb)

Inspired by the sporadic, perhaps discordant arrangement of barnacles on a rock surface, the 21 is fabricated from thin sheets of porcelain wrapped around frosted borosilicate glass trumpet-shaped diffusers. Each diffuser houses a low voltage (12V, 20W xenon) lamp. A strong contrast is established between the organically distributed soft light passing through the translucent white porcelain skin and the sharp, crisp light passing through the borosilicate glass diffuser.

APPLICATIONS

Suitable for residential and commercial use. CSA and CE approved; approved to UL standards by CSA. Popular applications to date include clusters over tables in residential dining rooms and restaurants, accessory lighting in living rooms, decorative lighting, linear configurations or clusters over bars and kitchen islands, large chandeliers in building lobbies and other public spaces.

MATERIALS

Porcelain, blown borosilicate glass, braided metal coaxial cable, electrical components and a matte white powder coated canopy.

Note: Longest and shortest lengths may have a variance of $\pm 50\text{mm}$ (2')

Note: As an alternative to a built-in transformer, Bocci recommends mounting transformers remotely in an easily accessible and hidden location for ease of long-term maintenance.

Purchase replacement lamps online at www.bocci.ca/lamps

Unless otherwise noted when ordering, all chandeliers will be outfitted to be xenon compatible.

Made in Vancouver, Canada

For additional information, please contact:

BOCCI Vancouver
info@bocci.ca
www.bocci.ca

BOCCI Berlin
infoeu@bocci.ca
www.bocci.ca

ROUND

21.36

Design by Omer Arbel
PRODUCT SPECIFICATION

© 2010, Bocci Design and Manufacturing Inc. All rights reserved. These drawings and the information contained herein may not be reproduced, communicated to the public, or made available in whole or in part without prior permission. Any inquiries should be directed to the following email address: admin@bocci.ca.

BOCCI

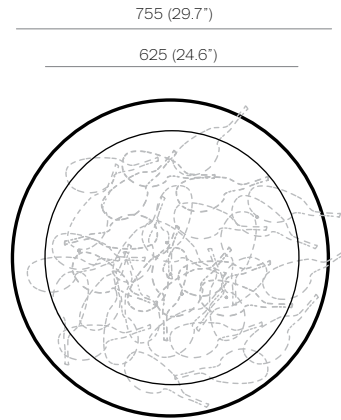

1

Measure and mark the chandelier canopy position on the ceiling.

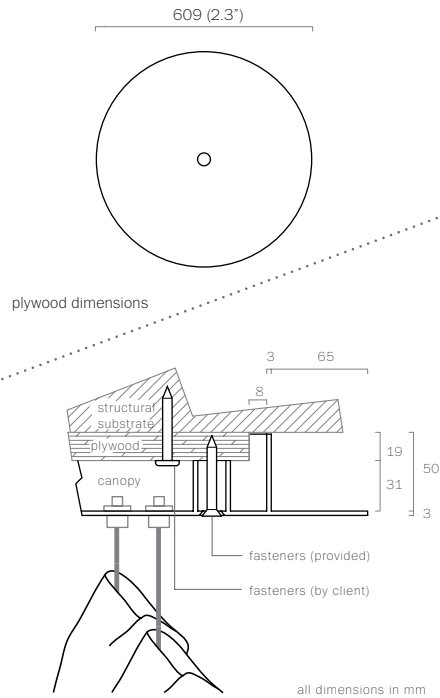

2

Note: The client is responsible for providing a robust 3/4" (19mm) plywood backing or wood blocking to securely anchor to the structural substrate.

Connections from the plywood to the structural substrate are the client's responsibility. Measure the plywood so that it fits within the canopy side walls (refer to detail above).

Anchor the plywood backing to the structural ceiling substrate.

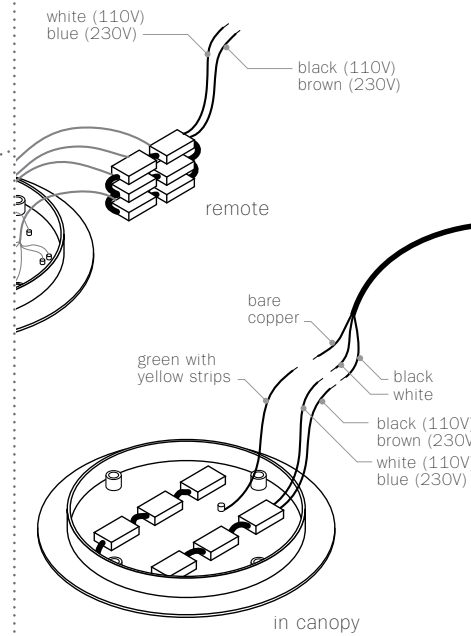

3

Connect transformers inside the canopy to line voltage. 110 V or 230 V depending on transformer.

For 110 V, connect black wire to the black wire and white wire to the white wire.

For 230 V, connect black wire to the brown wire and white wire to the blue wire.

Note: As an option, Bocci recommends mounting transformers remotely in a close, accessible and hidden location for ease of long term maintenance. Installation to be done by certified personnel to insure compliance with the code.

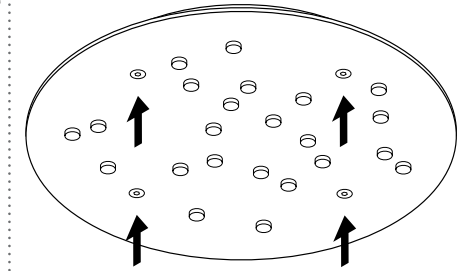

4

Anchor canopy into the plywood backing using the fasteners provided.

If your chandelier has multiple canopies, mount all canopies, one by one, per the previous steps. If your chandelier has only one canopy, proceed to step 5.

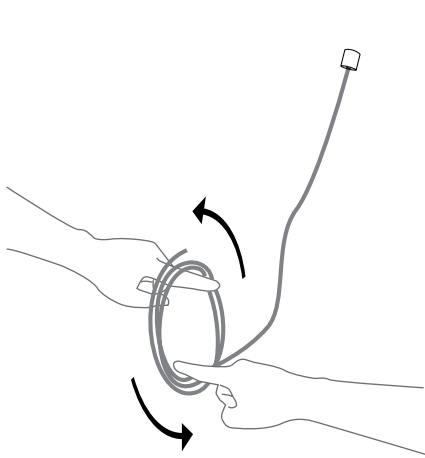

5

Very carefully uncoil the braided coaxial cable in a spool like manner. Insert your index fingers into opposite sides of the roll then rotate your fingers in a spool like manner around each other to unroll the coaxial cable. Use patience: allow the cable to uncoil completely to avoid kinks.

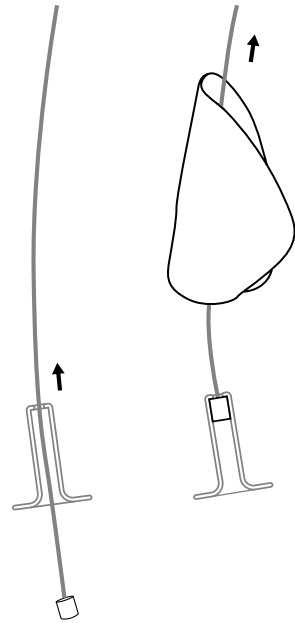

6

Put coaxial cable into the glass trumpet, which then threads through the pendant shade.

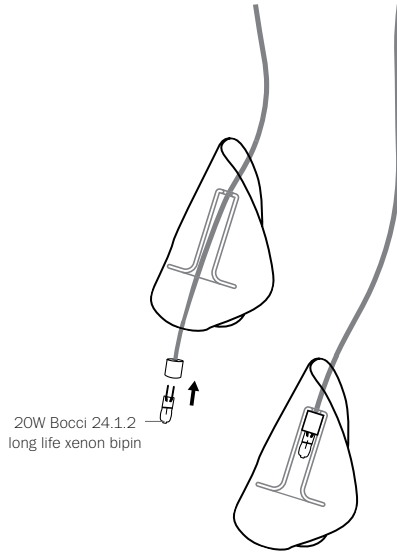

20W Bocci 24.1.2
long life xenon bipin

7

The 21 pendants are very fragile. Exercise extreme care while handling them.

Each pendant terminates in a "headphone jack" type connector, which plugs into a receiving receptacle in the canopy. Clients are encouraged to compose their own pendant configuration on site, thus creating a truly unique chandelier. After plugging in each pendant, turn the threaded sheathing into place by hand ensuring that it is adequately tightened. Tools are not required.

24.1.2 Bocci long life bipin xenon lamps included.

Plug the lamps to the sockets. Do not touch the lamps with your bare hands.

Purchase replacement lamps online at www.bocci.ca/lamps

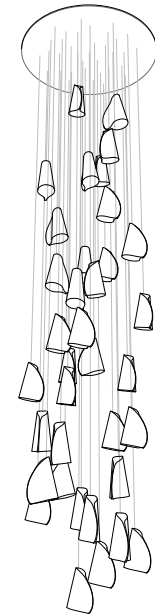

8

Turn fixture on.

Note: when using a dimmer, use only low voltage electronic dimmer.

For additional assistance, please contact Bocci:

BOCCI Vancouver
info@bocci.ca
www.bocci.ca

BOCCI Berlin
infoeu@bocci.ca
www.bocci.ca

Made in Vancouver, Canada

Approved to UL standards by CSA



ROUND

21.36

Design by Omer Arbel
INSTALLATION INSTRUCTIONS

© 2010, Bocci Design and Manufacturing Inc. All rights reserved. These drawings and the information contained herein may not be reproduced, communicated to the public, or made available in whole or in part without prior permission. Any inquiries should be directed to the following email address: admin@bocci.ca.

BOCCI