

Molteni & C

5050— RODOLFO DORDONI 2016

1—
2



The wealth of materials used and a rigorous design are the elements that characterize 5050, a collection of bedroom furniture designed by Rodolfo Dordoni. Gloss or matt lacquered surfaces alternate with wooden tops and Eco Skin trays, creating alternating color effects that please the eye and underscore the play of solids and voids of a geometric design that is never banal. An interesting feature is the rounded contour of the structural elements that make up bedside tables and chests of drawers.

DATASHEET

REGISTERED
DESIGN

VII.2016

molteni.it

Dimensions in millimeters and inches. The right to discontinue and make changes is reserved. This information is based on the latest product information available at the time of printing.

FINISHES

SIDES, FRONTS AND BACK
matt lacquer colours in the Molteni colour range
glossy lacquer colours in the Molteni colour range

TOPS AND BASES
eucalyptus
grey oak
graphite oak

CHEST OF DRAWERS LOWER SHELF IN ECO SKIN
grey
mink
hemp
ivory
dark brown

TECHNICAL INFORMATION

TOP, STRUCTURE FOR DRAWER AND BASE
Chipboard panel covered in Eucalyptus wood (Eucalyptus Globulus) and Oak (Quercus) veneer.

LATERAL PIECES AND SHELVES, SIDES AND INTERNAL DRAWER BOTTOM
Chipboard panel covered in melamine facing.

LATERAL PIECES AND FRONTS
Medium density fibre panel covered in melamine facing, painted in Molteni range colours.

BACK
Chipboard panel covered in melamine facing, painted in Molteni range colours.

COVERED TOP
Chipboard panel covered in Eco Skin.

FRONT PIECE IN SOLID WOOD
In solid wood of the Large-leaved Linden (Tilia Platyphyllos) covered in Eucalyptus wood (Eucalyptus Globulus) and Oak (Quercus) veneer).

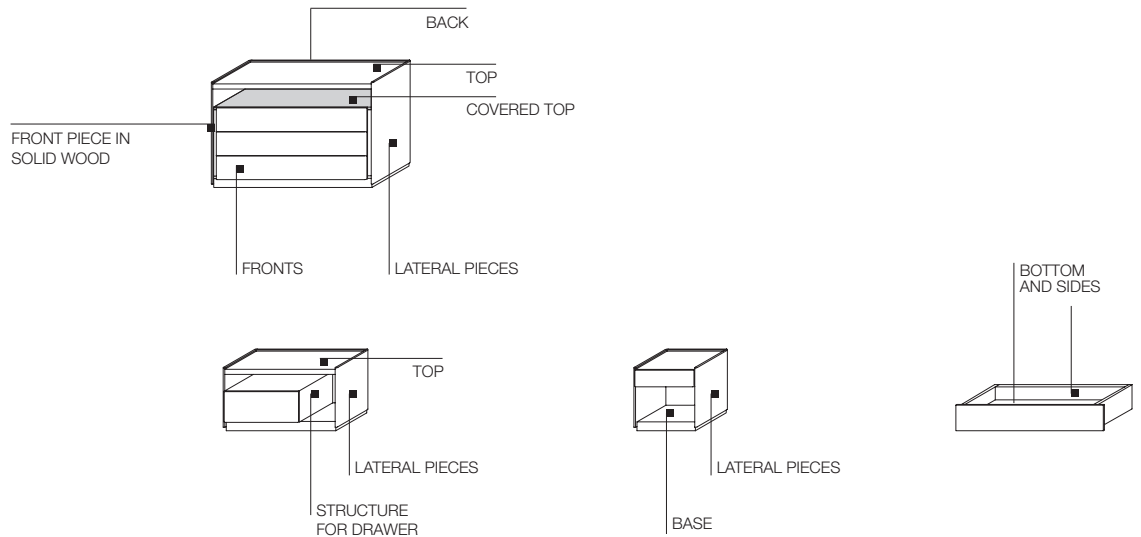

DIMENSIONS

night table
W 500 D 448 H 505
W 19 5/8" D 17 5/8" H 19 7/8"

night table
W 900 D 448 H 505
W 35 3/8" D 17 5/8" H 19 7/8"
drawer W 580 - 22 7/8"

chest of drawers
W 1277 D 538 H 850
W 50 1/4" D 21 1/8" H 33 1/2"

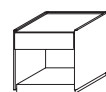

CCD1

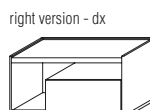

CCD2 dx - sx

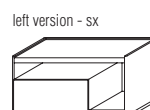

left version - sx

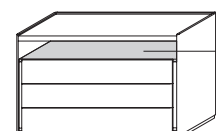

CCM1

lower shelf
Eco Skin
covered

FINISHES MOLTENI&C RANGE

IX.2016

	MATT LACQUER OPEN GRAIN LACQUER	GLOSSY LACQUER	COLOURED GLASS	ETCHED COLOURED GLASS	PLASTER LACQUERED CARTAPAGLIA LACQUERED <i>only Gliss Master</i>	STOPSOL
CHALK WHITE	•	•	•	•	•	
IVORY	•				•	
PEARL	•	•	•	•	•	
SILICA	•	•	•	•	•	
SAND	•	•	•	•	•	
PLATINUM	•	•	•	•	•	
DUNE	•	•	•	•	•	
CLAY	•	•	•	•	•	
DOLOMITE GREY	•	•	•	•	•	
RUBY	•	•	•	•	•	
CARAMEL	•	•	•	•	•	
MOKA	•	•	•	•	•	
MUSTARD	•	•	•	•	•	
CADMIUM	•	•	•	•	•	
LIGHT BLUE GREY	•	•	•	•	•	
BALTIC GREEN	•	•	•	•	•	
LEAD	•	•	•	•	•	
ANTHRACITE	•	•	•	•	•	
BLACK	•	•	•	•	•	
BRONZE				•		
GREY						•
LESSLESS RED <i>only matt lacquer</i>	•					

FINISHES MOLTENI&C RANGE

IX.2016

WOODS

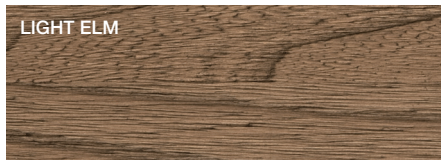
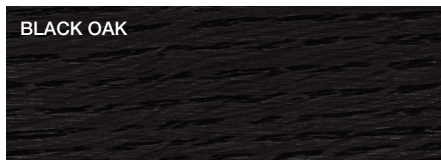
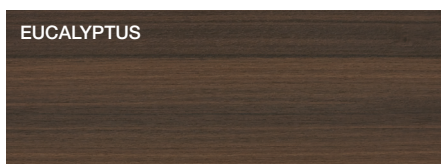

MARBLES

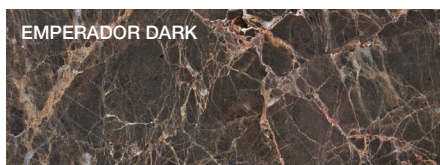
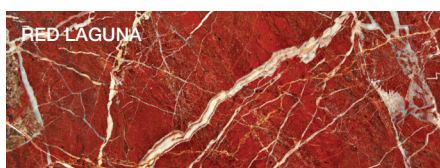
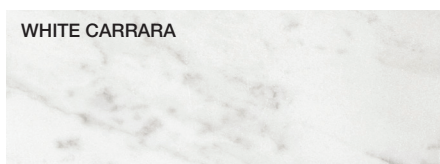

GRES

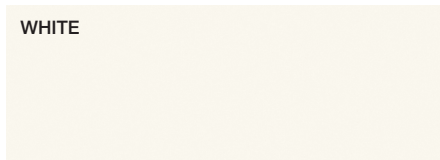

METAL PARTS

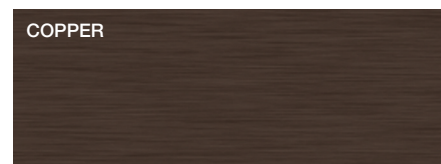
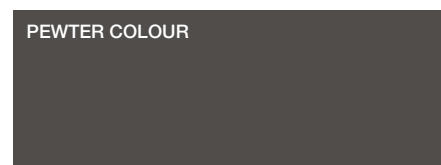
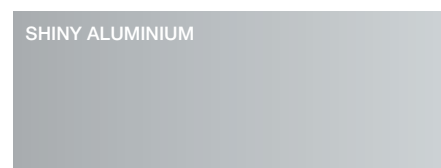
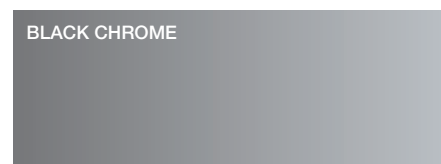

DWELL
DOOR FRAME, TRACK COVERING PROFILES

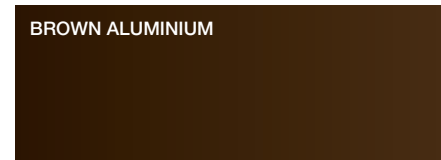

FINISHES MOLTENI&C RANGE

IX.2016

CARTAPAGLIA
GLISS MASTER, GLISS WALK-IN FRONT

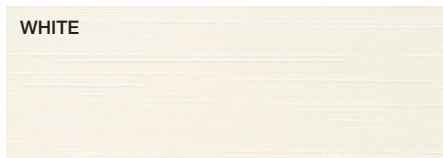

CARTAPAGLIA
GLISS MASTER FRONT

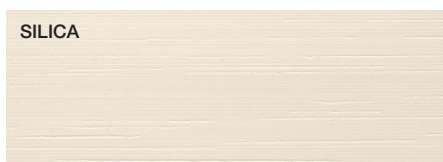

PLASTER
GLISS MASTER FRONT

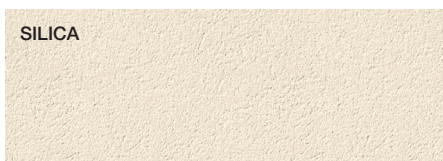

MILLERIGHE
GLISS MASTER, GLISS WALK-IN STRUCTURE



MELAMINE STRUCTURE
GLISS MASTER, GLISS WALK-IN



ECO SKIN

