

# Molteni & C

## **FILIGREE —** RODOLFO DORDONI 2013

1—  
3



Filigree is a range of fixed size and extension tables. Glossy and matt diecast aluminium frames underpin tops enhanced by a wide range of finishes. The technology used in the discreet Filigree main element allows an extendable table with an invisible lateral telescopic system. The entire top is without cuts, and extends to double its size. It allows the maximum use of space thanks to the outer legs, minimum thickness of the tops, and above all its mechanism containment structure and extensions which are only 38 mm internal thickness. The tables are available in different materials and finishes to meet all needs.

### DATASHEET

REGISTERED  
DESIGN

VII.2016

**molteni.it**

Dimensions in millimeters and inches. The right to discontinue and make changes is reserved. This information is based on the latest product information available at the time of printing.

## FINISHES

### TOP FINISHES

woods (eucalyptus, grey oak, graphite oak, light elm, dark elm) - matt lacquer colours in the Molteni colour range - coloured glass in the Molteni colour range (only for fixed tables) - etched coloured glass in the Molteni colour range (only for fixed tables) - white or anthracite gres (only for fixed tables) - Fenix white or anthracite (only for extendable table) - black marquina marble (only for fixed tables) - emperador dark marble (only for fixed tables) - white Carrara marble (only for fixed tables) - Sahara noir marble (only for fixed tables)

### STRUCTURE FINISHES

shiny aluminium - black chrome - eucalyptus (only for fixed tables)

# Molteni & C

## TECHNICAL INFORMATION

### FIXED TABLE STRUCTURE

Aluminium extrusion anodised or clad with sliced Eucalyptus wood, with internal metal frame and laminated struts.

### EXTENDABLE TABLE STRUCTURE

Anodised extruded aluminium with internal metal frame and runners on extruded aluminium tracks. Telescopic cover profile of the extendable table in extruded plastic.

### GLASS TOP

Transparent or etched extra light glass, tempered, th. 6 mm, painted in colours in the Molteni range.

### WOOD TOP AND EXTENSIONS

Composite panel of medium density fibre and aluminium sheets, th. 1mm, covered in Oak (Quercus), Elm (Ulmus rubra) or Eucalyptus (Eucalyptus globulus) veneer, FENIX NTM® laminate or painted in colours in the Molteni range.

### GRES TOP

Porcelained gres, th. 6mm, made with a sintering process, mass coloured.

### MARBLE TOP

Marble in Range finishes with anti-stain, water-repellent treatments.

### FIXED TABLE BASE

Wood particleboard panel with painted melamine facing.

### EXTENDABLE TABLE BASE

Medium density fibre composite panel with external surface in anodised aluminium sheet, th. 1mm.

### LEG

In die cast aluminium shiny brushed, chromed, or clad in sliced Eucalyptus wood. Internal metal brace and foot in non-slip plastic.

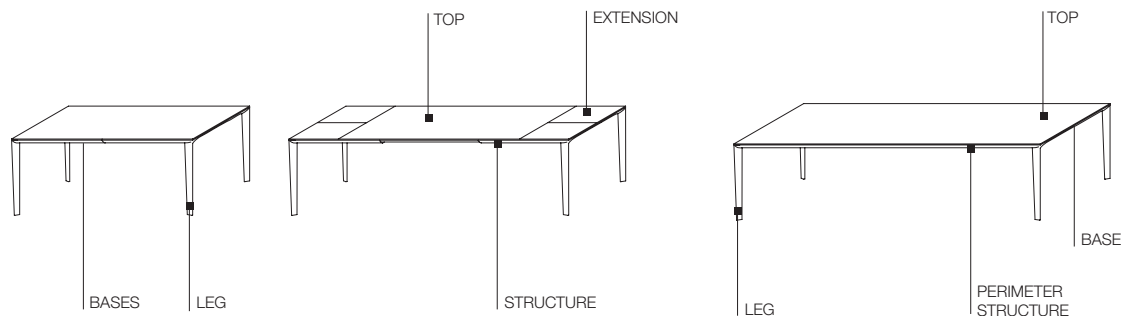

## DATASHEET

REGISTERED  
DESIGN

VII.2016

**molteni.it**

Dimensions in millimeters and inches. The right to discontinue and make changes is reserved. This information is based on the latest product information available at the time of printing.

**DIMENSIONS**

**extendable rectangular table**

W 1800 opened 2290/2780  
W 70 7/8" opened 90 1/8" /109 1/2"  
D 980 H 740  
D 38 5/8" H 29 1/8"

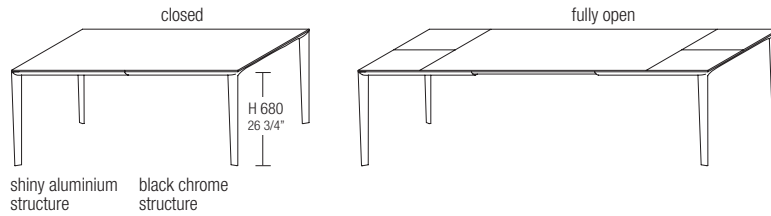

shiny aluminium structure  
black chrome structure

**FTA18/10**

**top**

matt lacquer colours/fenix  
woods

**fixed rectangular tables**

W 1800 D 980 H 740  
W 70 7/8" D 38 5/8" H 29 1/8"

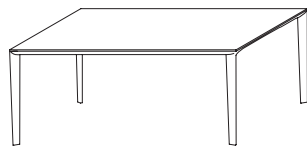

shiny aluminium structure  
black chrome structure  
eucalyptus structure

**FTF18/10**

**top**

matt lacquer colours  
woods  
coloured/etched coloured glass  
white or anthracite gres  
marble  
Sahara marble

W 2100 D 980 H 740  
W 82 3/4" D 38 5/8" H 29 1/8"

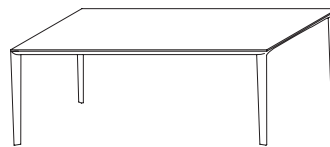

shiny aluminium structure  
black chrome structure  
eucalyptus structure

**FTF21/10**

**top**

matt lacquer colours  
woods  
coloured/etched coloured glass  
white or anthracite gres  
marble  
Sahara marble

W 2400 D 980 H 740  
W 94 1/2" D 38 5/8" H 29 1/8"

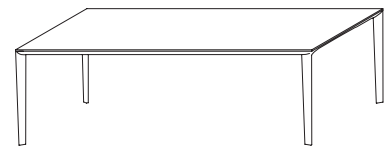

shiny aluminium structure  
black chrome structure  
eucalyptus structure

**FTF24/10**

**top**

matt lacquer colours  
woods  
coloured/etched coloured glass  
white or anthracite gres  
marble  
Sahara marble

**fixed rectangular table**

W 2980 D 1200 H 740  
W 117 3/8" D 47 1/4" H 29 1/8"

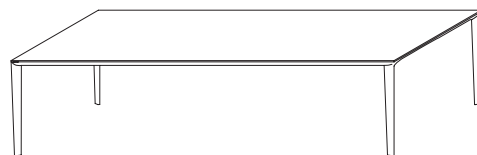

shiny aluminium structure  
black chrome structure  
eucalyptus structure

**FTF28/12**

**top**

matt lacquer colours  
woods  
coloured/etched coloured glass  
white or anthracite gres  
marble

**fixed square table**

W 1480 D 1480 H 740  
W 58 1/4" D 58 1/4" H 29 1/8"

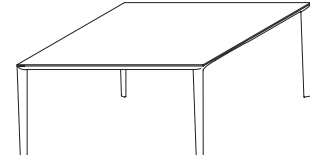

shiny aluminium structure  
black chrome structure  
eucalyptus structure

**FTF15/15**

**top**

matt lacquer colours  
woods  
coloured/etched coloured glass  
white or anthracite gres  
marble  
Sahara marble

**DATASHEET**

REGISTERED  
DESIGN

VII.2016

# Molteni & C

## FINISHES MOLTENI&C RANGE

IX.2016

	MATT LACQUER OPEN GRAIN LACQUER	GLOSSY LACQUER	COLOURED GLASS	ETCHED COLOURED GLASS	PLASTER LACQUERED CARTAPAGLIA LACQUERED <i>only Gliss Master</i>	STOPSOL
CHALK WHITE	•	•	•	•	•	
IVORY	•				•	
PEARL	•	•	•	•	•	
SILICA	•	•	•	•	•	
SAND	•	•	•	•	•	
PLATINUM	•	•	•	•	•	
DUNE	•	•	•	•	•	
CLAY	•	•	•	•	•	
DOLOMITE GREY	•	•	•	•	•	
RUBY	•	•	•	•	•	
CARAMEL	•	•	•	•	•	
MOKA	•	•	•	•	•	
MUSTARD	•	•	•	•	•	
CADMIUM	•	•	•	•	•	
LIGHT BLUE GREY	•	•	•	•	•	
BALTIC GREEN	•	•	•	•	•	
LEAD	•	•	•	•	•	
ANTHRACITE	•	•	•	•	•	
BLACK	•	•	•	•	•	
BRONZE				•		
GREY						•
LESSLESS RED <i>only matt lacquer</i>	•					

# Molteni & C

## FINISHES MOLTENI&C RANGE

IX.2016

### WOODS

EUCALYPTUS

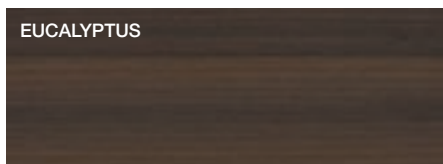

AMERICAN WALNUT



GRAPHITE OAK

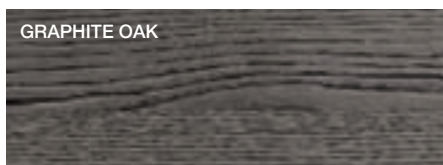

GREY OAK



BLACK OAK



DARK ELM



LIGHT ELM



CEDAR



### MARBLES

WHITE CARRARA

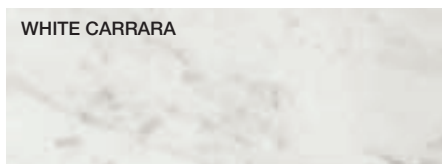

RED LAGUNA

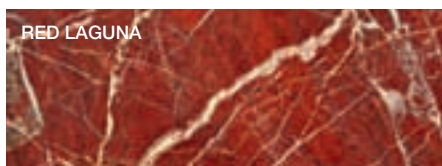

EMPERADOR DARK

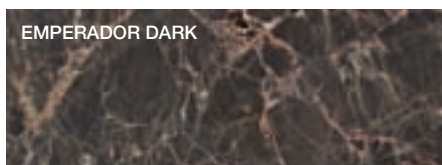

BLACK MARQUINA

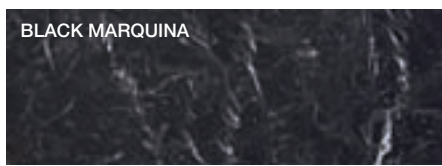

SAHARA NOIR



### GRES

WHITE



ANTHRACITE



### METAL PARTS

BLACK CHROME

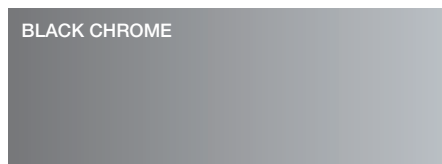

SHINY ALUMINIUM

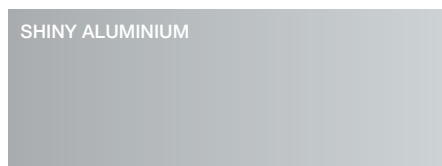

PEWTER COLOUR

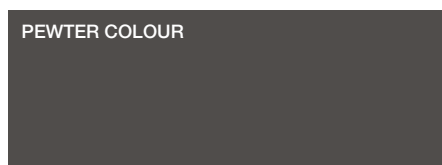

COPPER

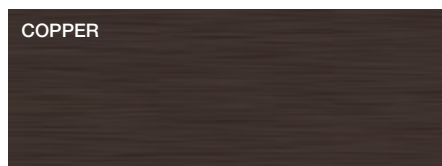

DWELL  
DOOR FRAME, TRACK COVERING PROFILES

ANODISED ALUMINIUM



BROWN ALUMINIUM



The finishes shown are indicative and refer to the entire production range. We recommend that you consult the "Colour Range" samples which shown the complete range of finishes, including those not shown here. Molteni&C reserves the right to modify the range without warning.