

Molteni & C

808— MDT 2007

1—
3



A system of storage units with drawers for any room in the house, in all sizes and colours. The product's main characteristic is the drawer front in two parts: the inside part is always in the same finish as the structure; the outer part is shaped to form the handle, available in several finishes that can be matched without depending on the finish of the internal part. The drawers have soft closing runners.

DATASHEET

REGISTERED
DESIGN

I.2015

molteni.it

Dimensions in millimeters and inches. The right to discontinue and make changes is reserved. This information is based on the latest product information available at the time of printing.

FINISHES

STRUCTURE AND INTERIOR FRONT FINISHES
(always in the same finishes)

FRONT FINISHES
(the finishes can differ from those of the structure)

MATT LACQUER STRUCTURE / INTERIOR FRONT / FRONT FINISHES
in the Molteni range colours

GLOSSY LACQUER FRONT FINISHES
in the Molteni range colours

WOODEN STRUCTURE / INTERIOR FRONT / FRONT FINISHES
grey oak - black oak - light elm - dark elm

TECHNICAL INFORMATION

STRUCTURE, BASE AND BACK (WOOD VERSION)
Panel of particle wood faced with Oak (Quercus) or Elm (Ulmus rubra) veneer wood.

STRUCTURE, BASE AND BACK (MATT LACQUERED VERSION)
Panel of particle wood coated with melamine paper painted in the colours of the Molteni range.

BOTTOM FRONT AND FRONT (WOOD VERSION)
MDF panel faced with Oak or Elm veneer wood.

BOTTOM FRONT AND FRONT (MATT LACQUERED VERSION)
MDF panel coated with melamine paper painted in the colours of the Molteni range.

FRONT (GLOSSY LACQUERED VERSION)
MDF panel, painted in the glossy polyester finish in the colours of the Molteni range.

DRAWER INNER SIDES
Support made of a central multilayer panel with MDF panels on the outside, coated with melamine paper.

DRAWER INNER BOTTOM
Panel of particle wood coated with melamine paper.

ADJUSTABLE FEET
Non-skid plastic material.

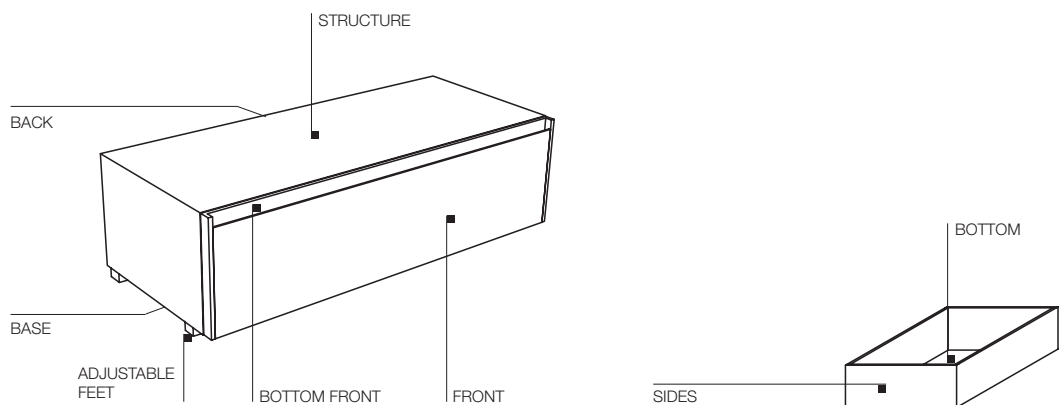

DATASHEET

REGISTERED
DESIGN

I.2015

DIMENSIONS

drawer units

W 500 D 540 H 360
W 19 3/4" D 21 1/4" H 14 1/8"

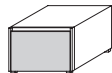

CT05/03

W 750 D 540 H 360
W 29 1/2" D 21 1/4" H 14 1/8"



CT07/03

Molteni & C

drawer units

W 500 D 540 H 450
W 19 3/4" D 21 1/4" H 17 3/4"

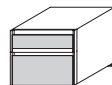

CT05/04

W 750 D 540 H 450
W 29 1/2" D 21 1/4" H 17 3/4"

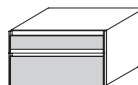

CT07/04

3—
3

drawer units

W 750 D 540 H 740
W 29 1/2" D 21 1/4" H 29 1/8"

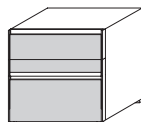

CT07/07

W 1250 D 540 H 740
W 49 1/4" D 21 1/4" H 29 1/8"

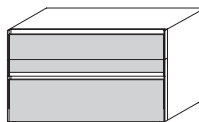

CT12/07

drawer units

W 500 D 540 H 1410
W 19 3/4" D 21 1/4" H 55 1/2"

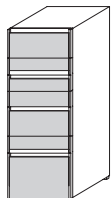

CT05/13

DATASHEET

REGISTERED
DESIGN

I.2015

molteni.it

Dimensions in millimeters and inches. The right to discontinue and make changes is reserved. This information is based on the latest product information available at the time of printing.

FINISHES

	MATT LACQUER/ OPEN GRAIN LACQUER	GLOSSY LACQUER	COLOURED GLASS	ETCHED COLOURED GLASS
CHALK WHITE	•	•	•	•
IVORY	•			
PEARL	•	•	•	•
SILICA	•	•	•	•
SAND	•	•	•	•
PLATINUM	•	•	•	•
DUNE	•	•	•	•
CLAY	•	•	•	•
DOLOMITE GREY	•	•	•	•
BORDEAUX	•	•	•	•
MOKA	•	•	•	•
ORANGE	•	•	•	•
MUSTARD	•	•	•	•
CARAMEL	•	•	•	•
LIGHT BLUE GREY	•	•	•	•
AQUAMARINE	•	•	•	•
VENETIAN RED	•	•	•	•
LEAD	•	•	•	•
ANTHRACITE	•	•	•	•
BLACK	•	•	•	•
LESSLESS RED	only matt lacquer •			

FINISHES

WOODS

EUCALYPTUS



AMERICAN WALNUT

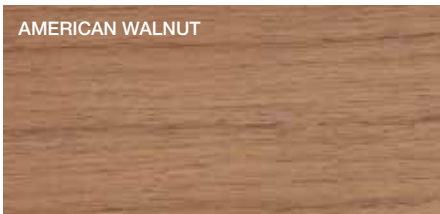

GREY OAK

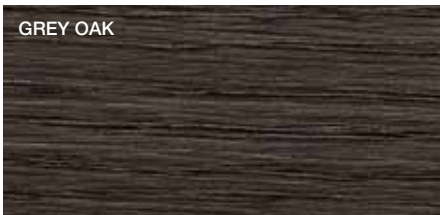

BLACK OAK

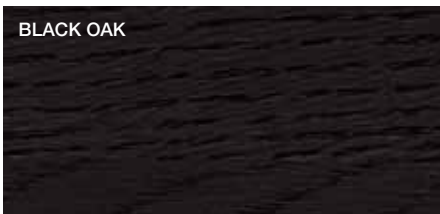

DARK ELM



LIGHT ELM

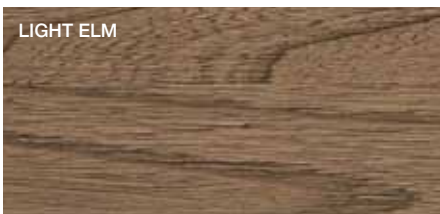

CEDAR



MARBLES

WHITE CARRARA MARBLE



CALACATTA MARBLE



RED FRENCH MARBLE



EMPERADOR DARK MARBLE



CARNIAN GREY MARBLE

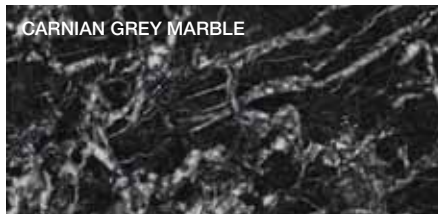

ABSOLUTE BLACK GRANITE



GRES

WHITE GRES



ANTHRACITE GRES



METAL PARTS

BLACK CHROME

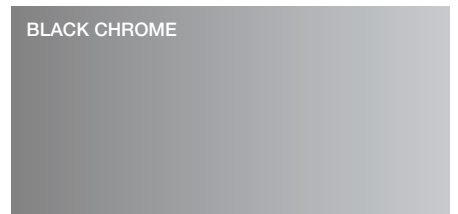

SHINY ALUMINIUM



PEWTER COLOUR

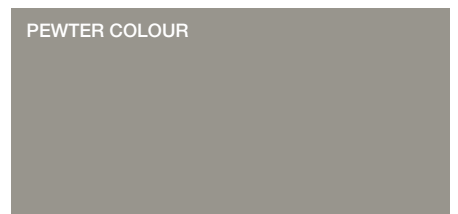

MILLERIGHE
GLISS QUICK FRONT



MILLERIGHE
GLISS QUICK, GLISS 5TH STRUCTURE



DWELL
DOOR FRAME, TRACK COVERING PROFILES

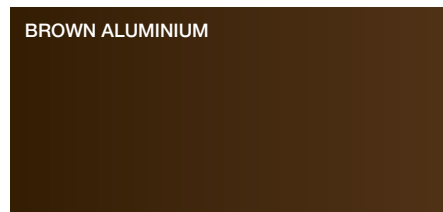

CARTAPAGLIA
GLISS QUICK, GLISS WALK-IN FRONT

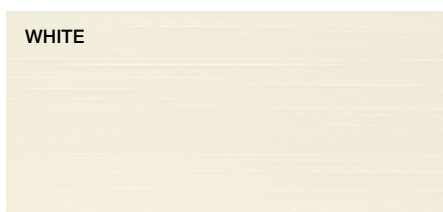

Millerighe dark finish available also for Gliss Walk-In where specifically indicated in the pricelist