

# Molteni & C

## 505 SIDEBOARD— NICOLA GALLIZIA 2013

1—  
7



Completing the 505 system, can be used to create compositions that are raised off the floor by adjustable feet. Offered in two depths (400 and 540), four heights and ten standard widths, the compositions can be given the same finishes and doors that are in the serie. The stylish adjustable foot is available in two finishes: shiny aluminium and black chrome. To enhance compositional potential, a new side panel height of 508-19" has been added, which is equivalent to 1½ modules.

**DATASHEET**

REGISTERED  
DESIGN

I.2015

**molteni.it**

Dimensions in millimeters and inches. The right to discontinue and make changes is reserved. This information is based on the latest product information available at the time of printing.



**MODULARITY**

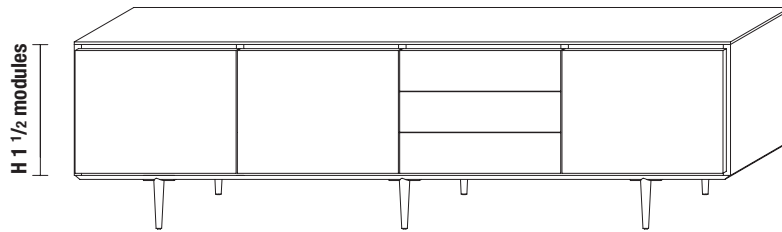

**Molteni & C**

3  
 7

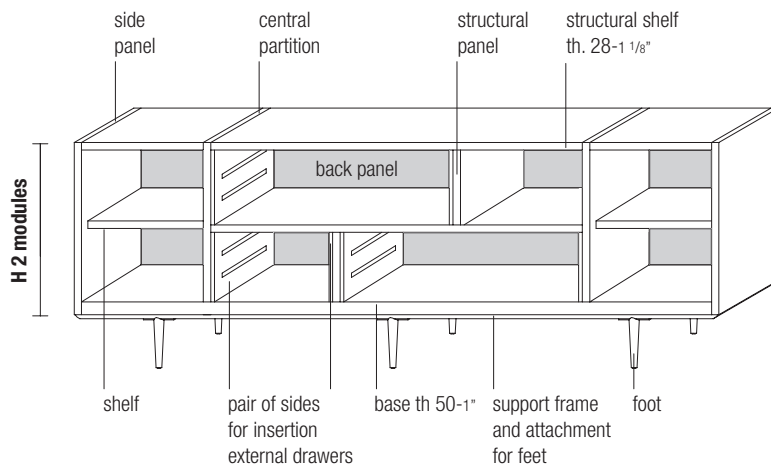
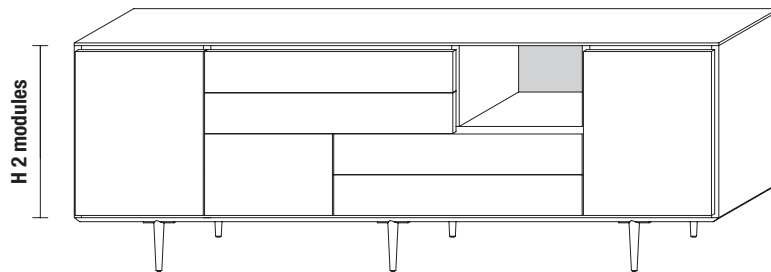
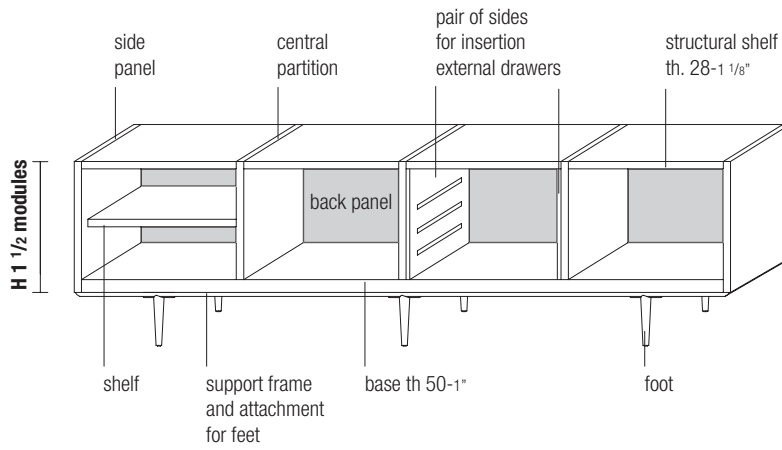

**DATASHEET**

REGISTERED  
 DESIGN

I.2015

## FINISHES

### Wood grain

#### Pressure opening th 40

- HORIZONTAL GRAIN for drawers and flap doors
- HORIZONTAL AND VERTICAL GRAIN for hinged doors

#### Pressure opening th 22

- HORIZONTAL GRAIN for drawers and flap doors
- VERTICAL GRAIN for hinged doors

#### Handle opening th. 22

- HORIZONTAL GRAIN for drawers
- VERTICAL GRAIN for hinged doors

### Handle

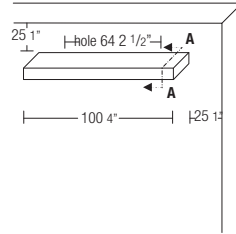

#### type B

handle opening th 22 (7/8")  
(always horizontally positioned).

#### section A-A

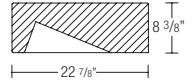

finishes:  
- shiny chrome  
- black chrome

finishes	matt lacquer colours	glossy lacquer colours	woods	special woods	transparent glass	coloured glass	coloured etched glass	shiny aluminium	black chrome
structure									
backs									
rear finishing panels									
opening th. 40 (hinged/flap/drawers)									
doors/external drawers with handle or pressure opening th. 22 / internal drawer units									
glass doors with shaped profile	trim								
	glass								
tops									
feet/support frame									

### colours

#### Matt lacquer

BC chalk white  
AV ivory  
PE pearl  
DN dune  
PL platinum  
PB lead  
NE black  
RT venetian red  
BO bordeaux  
AT anthracite  
SE mustard  
SI silica  
DO dolomite grey  
AL clay  
AR orange  
MK moka  
AQ aquamarine  
CM caramel  
CZ light blue grey  
SA sand

#### Glossy lacquer

BC chalk white  
PE pearl  
DN dune  
PL platinum  
PB lead  
NE black  
RT venetian red  
BO bordeaux  
AT anthracite  
SE mustard  
SI silica  
DO dolomite grey  
AL clay  
AR orange  
MK moka  
AQ aquamarine  
CM caramel  
CZ light blue grey  
SA sand

#### Woods

EU eucalyptus  
RG grey oak  
RN black oak  
  
**Special woods**  
OC light elm  
OS dark elm

#### Coloured glass

BC chalk white  
PE pearl  
DN dune  
PL platinum  
PB lead  
NE black  
RT venetian red  
BO bordeaux  
AT anthracite  
SE mustard  
SI silica  
DO dolomite grey  
AL clay  
AR orange  
MK moka  
AQ aquamarine  
CM caramel  
CZ light blue grey  
SA sand

#### Coloured etched glass

BC chalk white  
PE pearl  
DN dune  
PL platinum  
PB lead  
NE black  
RT venetian red  
BO bordeaux  
AT anthracite  
SE mustard  
SI silica  
DO dolomite grey  
AL clay  
AR orange  
MK moka  
AQ aquamarine  
CM caramel  
CZ light blue grey  
SA sand

### DATASHEET

REGISTERED  
DESIGN

I.2015

## INTERNAL DRAWER UNITS

### For open compartments and glass hinged doors with shaped profile

The internal drawer units can be positioned between two shelves th. 28 mm (1 1/8") (example **A**).

**All drawers are always with pressure opening and always fully extractable.**

The drawers are flush with the open compartment structure but aligned 18 mm (3/4") backwards (aligned with internal shelves) if using hinged glass doors.

**The compartment that holds the internal drawer unit must always have a back panel or a rear finishing panel. The internal drawer unit can be inserted in compositions H 2 and 4 modules, not setting on base.**

# Molteni & C

### Example A

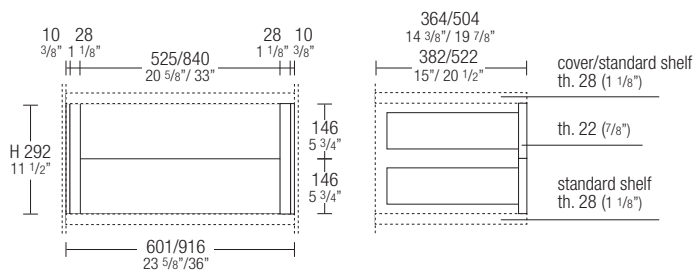

5—  
 7

## DOORS

### pressure opening th 40

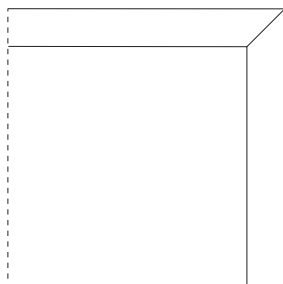

### pressure opening th 22

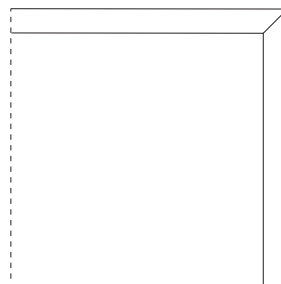

### glass door with shaped profile hinged opening

this handle is not available  
 for external drawers

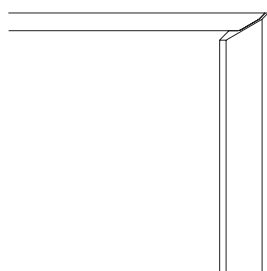

### opening with the handle th 22

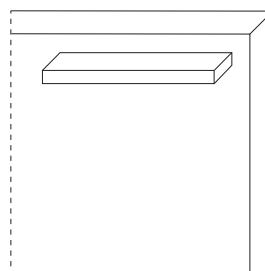

DATASHEET

REGISTERED  
 DESIGN

I.2015

**molteni.it**

Dimensions in millimeters and inches. The right to discontinue and make changes is reserved. This information is based on the latest product information available at the time of printing.

## EXTERNAL DRAWERS

Standard version comes with partially extractable runners.  
**Fully extractable runners are available with a surcharge.**

\* wooden drawers only with horizontal grain

### Notes

External drawers can be inserted in compartments with a th 16 mm back panel after installation of the pair of side panels indicated below.

### Drawers modularity

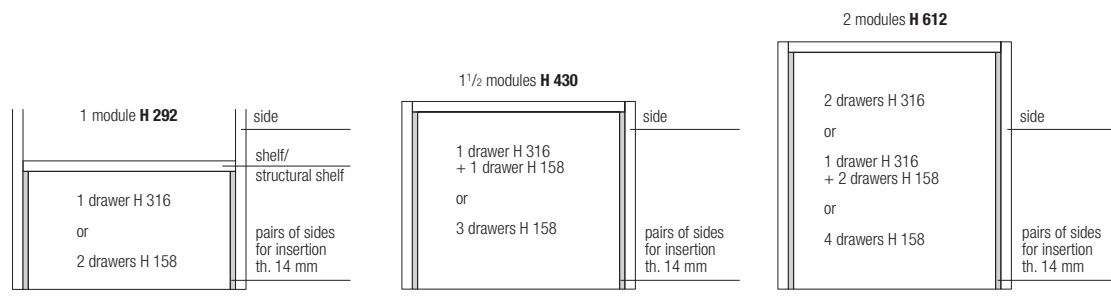

Molteni & C

6—  
 7

## SAMPLE COMPOSITIONS

**compositions**  
**H 568 - 22 3/8"**

**composition 1**  
 W 1288 D 426  
 W 50 3/4" D 16 3/4"  
 modules 630 - 630  
 (\*) th 40 - 1 5/8"

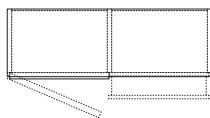
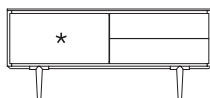

C01

**composition 2**  
 W 1918 D 566  
 W 75 1/2" D 22 1/4"  
 modules 945 - 472 - 472  
 (\*) th 40 - 1 5/8"

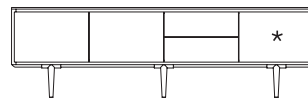

C02

**compositions**  
**H 568 - 22 3/8"**

**composition 3**  
 W 2548 D 566  
 W 100 3/8" D 22 1/4"  
 modules 472 - 472 - 945 - 630

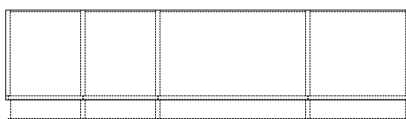
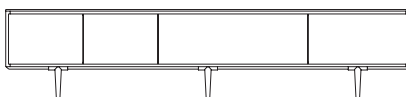

C03

**composition 4**  
 W 2548 D 566  
 W 100 3/8" D 22 1/4"  
 modules 630 - 630 - 630 - 630  
 (\*) th 40 - 1 5/8"

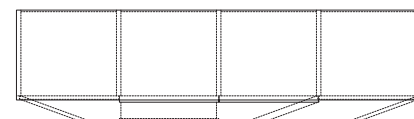
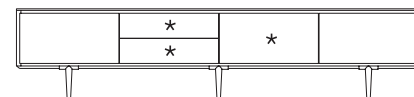

C04

DATASHEET

REGISTERED  
 DESIGN

I.2015

**molteni.it**

Dimensions in millimeters and inches. The right to discontinue and make changes is reserved. This information is based on the latest product information available at the time of printing.

**SAMPLE COMPOSITIONS**

**compositions**  
**H 728 - 28 5/8"**

**composition 5**  
 W 1918 D 566  
 W 75 1/2" D 22 1/4"  
 modules 472 - 472 - 472 - 472

**composition 6**  
 W 2548 D 426  
 W 100 3/8" D 16 3/4"  
 modules 630 - 630 - 630 - 630  
**(\*) th 40 - 1 5/8"**

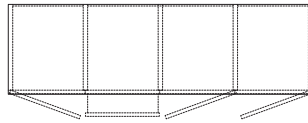
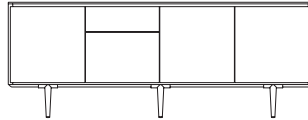

**C05**

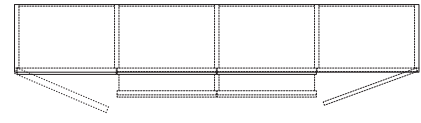
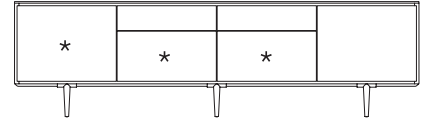

**C06**

**compositions**  
**H 1528 - 60 1/8"**

**composition 7**  
 W 1288 D 426  
 W 50 3/4" D 16 3/4"  
**(\*) th 40 - 1 5/8"**  
**glass doors with**  
**shiny aluminium profile**

**composition 8**  
 W 1288 D 426  
 W 50 3/4" D 16 3/4"  
**(\*) th 40 - 1 5/8"**

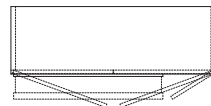
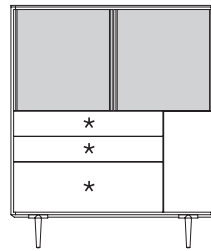

**C07**

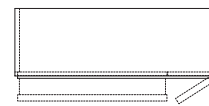
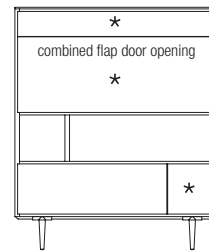

**C08**

**Molteni & C**

7—  
 7

**DATASHEET**

REGISTERED  
 DESIGN

I.2015

**molteni.it**

Dimensions in millimeters and inches. The right to discontinue and make changes is reserved. This information is based on the latest product information available at the time of printing.

# FINISHES

	MATT LACQUER/ OPEN GRAIN LACQUER	GLOSSY LACQUER	COLOURED GLASS	ETCHED COLOURED GLASS
CHALK WHITE	•	•	•	•
IVORY	•			
PEARL	•	•	•	•
SILICA	•	•	•	•
SAND	•	•	•	•
PLATINUM	•	•	•	•
DUNE	•	•	•	•
CLAY	•	•	•	•
DOLOMITE GREY	•	•	•	•
BORDEAUX	•	•	•	•
MOKA	•	•	•	•
ORANGE	•	•	•	•
MUSTARD	•	•	•	•
CARAMEL	•	•	•	•
LIGHT BLUE GREY	•	•	•	•
AQUAMARINE	•	•	•	•
VENETIAN RED	•	•	•	•
LEAD	•	•	•	•
ANTHRACITE	•	•	•	•
BLACK	•	•	•	•
LESSLESS RED	•			
	only matt lacquer			



# FINISHES

## WOODS

EUCALYPTUS



AMERICAN WALNUT

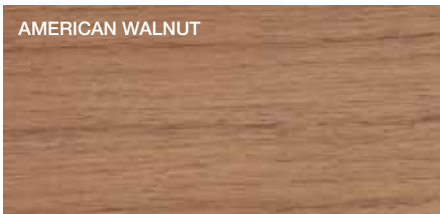

GREY OAK

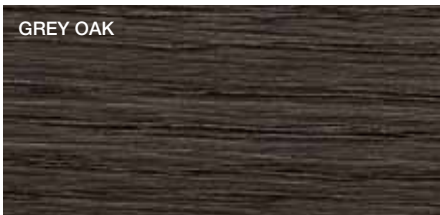

BLACK OAK

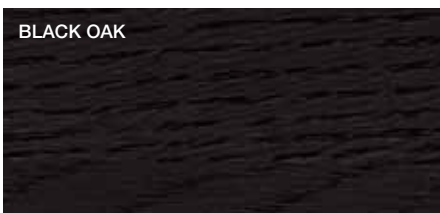

DARK ELM



LIGHT ELM

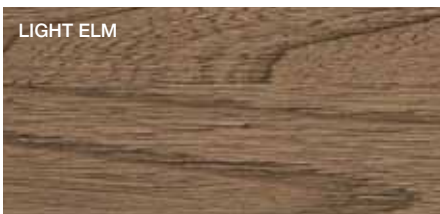

CEDAR



## MARBLES

WHITE CARRARA MARBLE



CALACATTA MARBLE



RED FRENCH MARBLE



EMPERADOR DARK MARBLE

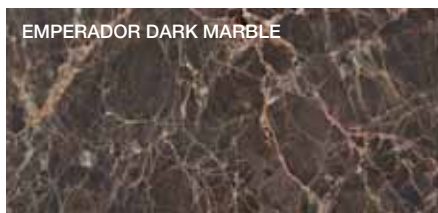

CARNIAN GREY MARBLE

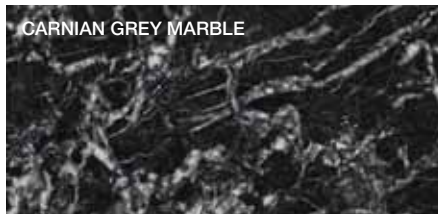

ABSOLUTE BLACK GRANITE



## GRES

WHITE GRES



ANTHRACITE GRES



## METAL PARTS

BLACK CHROME

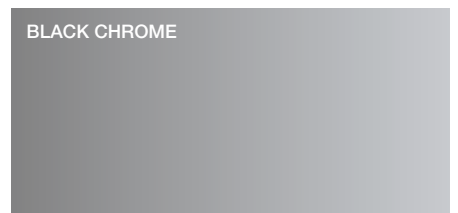

SHINY ALUMINIUM



PEWTER COLOUR

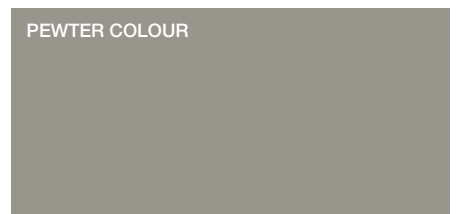

**MILLERIGHE**  
GLISS QUICK FRONT



**MILLERIGHE**  
GLISS QUICK, GLISS 5TH STRUCTURE



**DWELL**  
DOOR FRAME, TRACK COVERING PROFILES

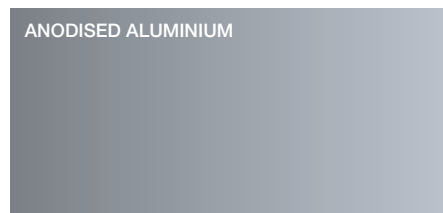

**CARTAPAGLIA**  
GLISS QUICK, GLISS WALK-IN FRONT

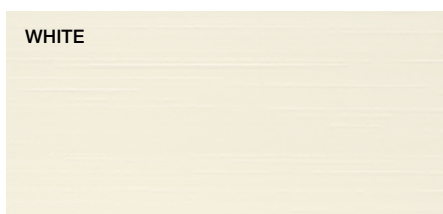

Millerighe dark finish available also for Gliss Walk-In where specifically indicated in the pricelist