



Turner, the new seating system designed by the designer Hannes Wettstein, combines comfort with refinement. Balanced volumes, controlled proportions, and a modern yet timeless look, characterise the design. Settees in various sizes, corner pieces, chaises-longue and pouf can be combined together to create different furnishing solutions. Molteni pays particular attention to the choice of leathers used to cover its products. They must have superior properties of softness and resistance to wear. *Turner* responds to varying needs in terms of comfort and posture, thanks to an easy mechanism which adjusts the depth of the seating. *Turner* is an excellent solution to the problem of how to combine elements thanks to a design logic based on modularity for traditional sofas, compositions with chaises longues and daybed islands.

■ Finishes

cover
fabric, leather

feet finishes
shiny aluminium
acquered nickel

■ Technical information

Structure interior	Frame made of solid fir (<i>Picea abies</i>) and chipboard, with elastic straps.
Structure padding	High capacity variable density foam polyurethane. Light velvet cover.
Seat cushions	Insert in shaped polyurethane and sterilised feathers. 100% cotton cover.
Back cushions	Polyurethane flakes and sterilised down feathers in compartments. 100% cotton cover.
Frame	Painted metal with feet in non-slip plastic.
Feet	Extruded aluminium, anodised or painted.
Removable outer covers	(See attached card, specific for each cover).

■ Compositions

composition 4
W 3010 D 1090
W 118 1/2" D 42 7/8"

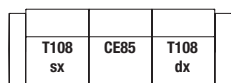

TC04

composition 10
W 3010 D 1090/2100
W 118 1/2" D 42 7/8" - 82 3/4"

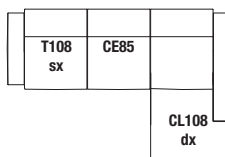

TC10

composition 23
W 3610 D 3320
W 142 1/8" D 130 3/4"

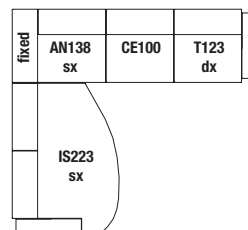

TC23

■ Dimensions

End units, central units, chaise longues and islands

Elements **cannot be used individually**.
All elements have back with mechanism.
The compositions are always closed at the side with an arm.

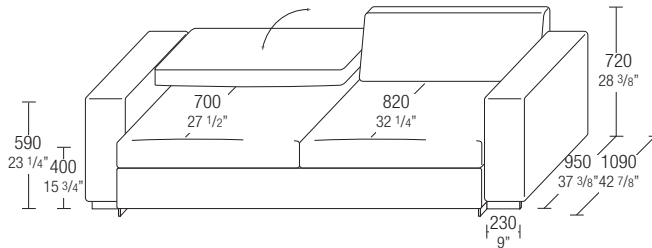

Corner

The corner element **cannot be used alone** but must be placed by a central, terminal or corner element, on the opposite side to the arm. The corner element comes with mechanism only on the long side.

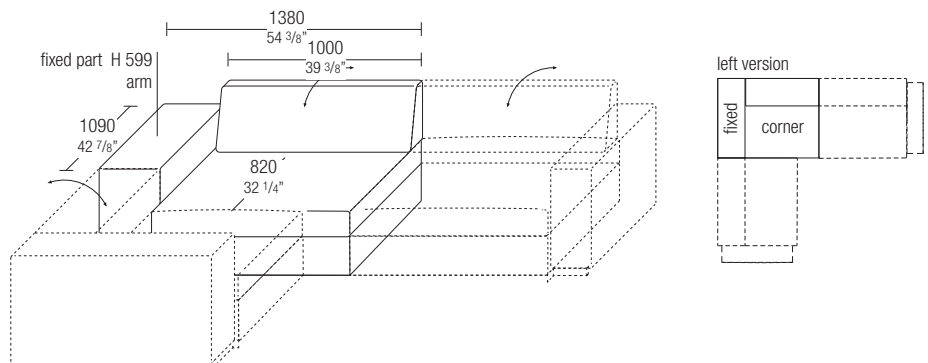

Island element

The island element cannot be used alone, but must be used along with a central, end or corner element on the side opposite the armrest.

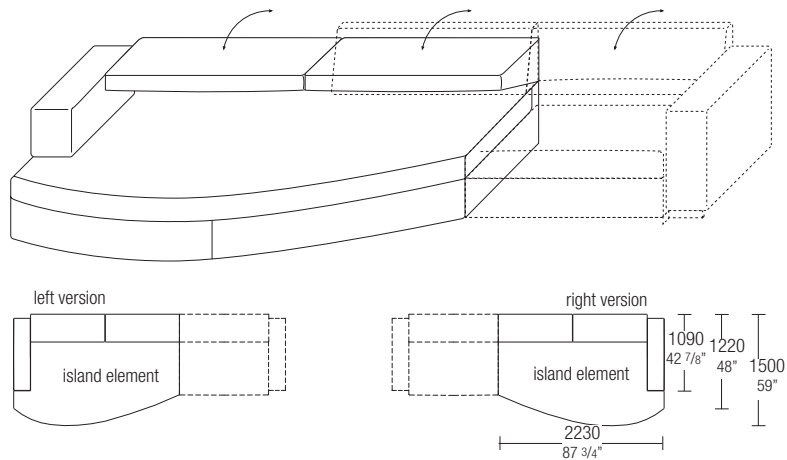

Sofa

The settee is a finite element which stands alone

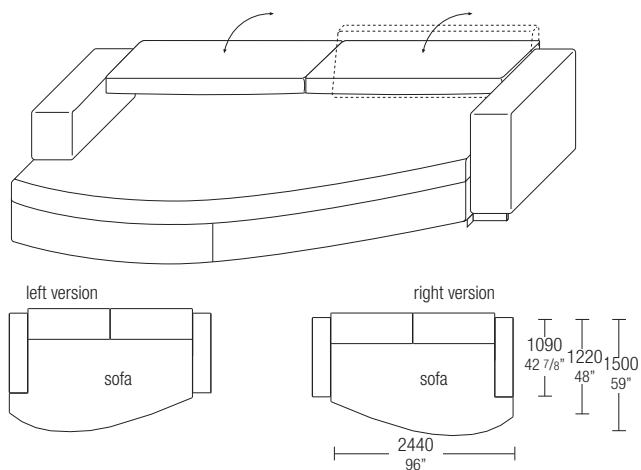

Molteni & C

■ Elements left version

end element

W 1080 D 1090 H 590/720
W 42 1/2" D 42 7/8" H 23 1/4" - 28 3/8"

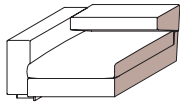

T108 dx - sx

W 1230 D 1090 H 590/720
W 48 3/8" D 42 7/8" H 23 1/4" - 28 3/8"

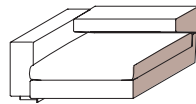

T123 dx - sx

W 1430 D 1090 H 590/720
W 56 1/4" D 42 7/8" H 23 1/4" - 28 3/8"

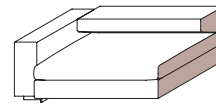

T143 dx - sx

central

W 850 D 1090 H 590/720
W 33 1/2" D 42 7/8" H 23 1/4" - 28 3/8"

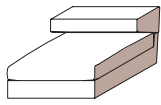

CE85

W 1000 D 1090 H 590/720
W 39 3/8" D 42 7/8" H 23 1/4" - 28 3/8"

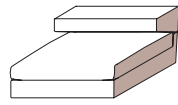

CE100

W 1200 D 1090 H 590/720
W 47 1/4" D 42 7/8" H 23 1/4" - 28 3/8"

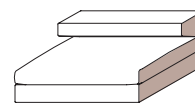

CE120

chaise longue

W 1080 D 2100 H 590/720
W 42 1/2" D 82 3/4" H 23 1/4" - 28 3/8"

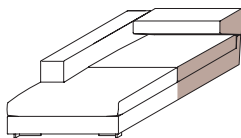

CL108 dx - sx

W 1230 D 1600 H 590/720
W 48 3/8" D 63" H 23 1/4" - 28 3/8"

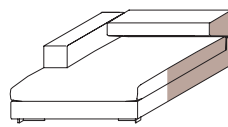

CL123 dx - sx

island

W 1080 D 2100 H 590/720
W 42 1/2" D 82 3/4" H 23 1/4" - 28 3/8"

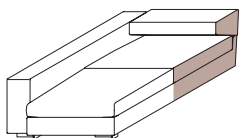

IS108 dx - sx

W 1230 D 1600 H 590/720
W 48 3/8" D 63" H 23 1/4" - 28 3/8"

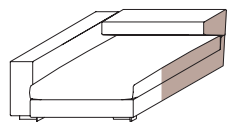

IS123 dx - sx

W 1430 D 1600 H 590/720
W 56 1/4" D 63" H 23 1/4" - 28 3/8"

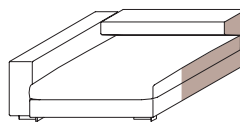

IS143 dx - sx

W 2230 D 1500 H 590/720
W 87 3/4" D 59" H 23 1/4" - 28 3/8"

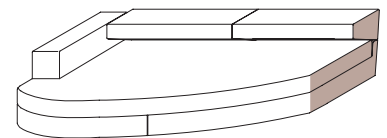

IS223 dx - sx

corner

W 1380 D 1090 H 590/720
W 54 3/8" D 42 7/8" H 23 1/4" - 28 3/8"

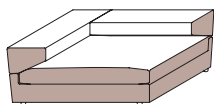

AN138 dx - sx

sofa

W 2440 D 1500 H 590/720
W 96" D 59" H 23 1/4" - 28 3/8"

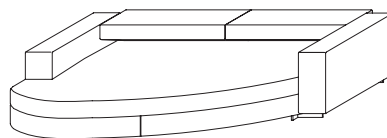

DI244 dx - sx

pouf

W 1000 D 850 H 400
W 39 3/8" D 33 1/2" H 15 3/4"

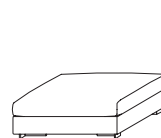

PF100

pouf

W 1200 D 1000 H 400
W 47 1/4" D 39 3/8" H 15 3/4"

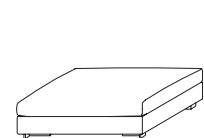

PF120

back cushion

W 600 H 600
W 23 5/8" D 23 5/8"

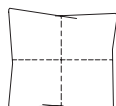

TCS60

W 700 H 600
W 27 1/2" D 23 5/8"

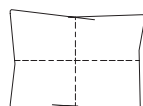

TCS70

W 800 H 600
W 31 1/2" D 23 5/8"

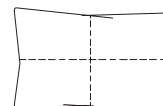

TCS80

pair of extra cushions

W 500 H 500
W 19 3/4" D 19 3/4"

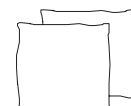

CCQ/50